

















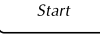



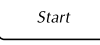
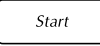

## QUICK GUIDE TO OPERATION

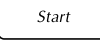
Feature	How to Operate
To Set <b>Clock</b> (see page 9)	 →  Thru  →  Press. Enter time of day. Press.
To Cook using <b>Quick Min</b> Pad (see page 9)	 →  (up to 10 min.) Press.
To Set <b>Power &amp; Time</b> (see page 9)	 →  Thru  →  Press to select Power Level Set cooking time. Press.
To Defrost using <b>Auto Defrost</b> Pad (see page 12)	 →  Thru  →  Press. Set weight. Press.
To use <b>Child Safety Lock</b> (see page 9)	 Hold "Start" Pad until "L" appears in the display.  Hold "Start" Pad until "L" disappears in the display.
To Cook using <b>Auto Cook</b> Pads (see page 14)	eg.  →  →  Select recipe Select serving/weight Press.
To Use as a <b>Kitchen Timer</b> (see page 10)	 →  Thru  →  Press. Press.
To reheat using <b>Auto Reheat</b> Pad (see page 11)	 →  Press. Press.

# Panasonic®

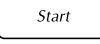
## Operating Instructions

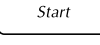
### Microwave Oven Models NN-S723WL NN-S723BL

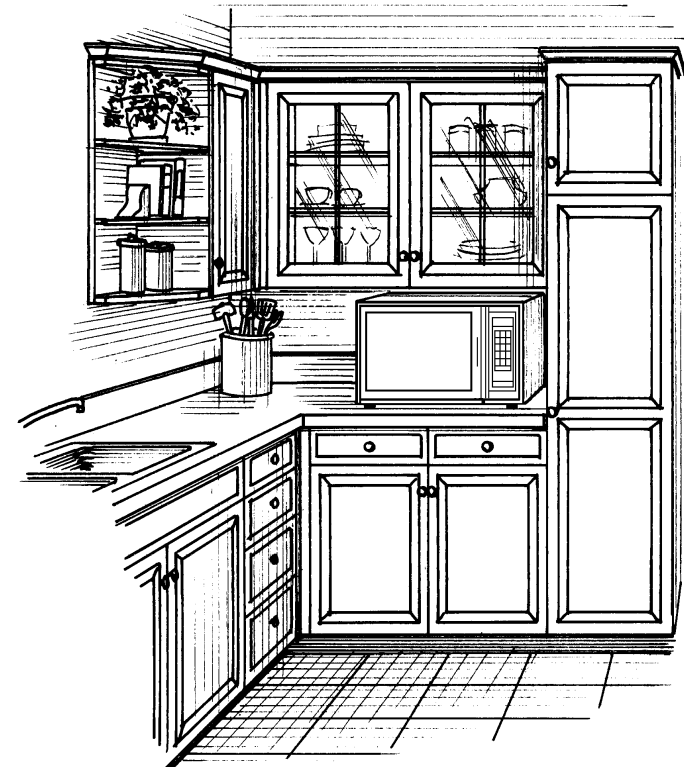

This manual contains Safety Instructions, Operating Instructions and Maintenance of the oven.  
 Before operating this oven, please read these instructions completely.  
 Antes de operar este producto, lea este instructivo en su totalidad.  
 El manual de instrucciones en español puede ser encontrada en la páginas 23-29  
 (Spanish Operating Instructions can be found on pages 23-29)

**Panasonic Consumer Electronics Company, Division of Matsushita Electric Corporation of America**  
 One Panasonic Way  
 Secaucus, New Jersey 07094

**Panasonic Sales Company, Division of Matsushita Electric of Puerto Rico, Inc. ("PSC")**  
 Ave. 65 de Infanteria, Km. 9.5  
 San Gabriel Industrial Park,  
 Carolina, Puerto Rico 00985

Part No. 3828W5A2829

For assistance, please call : 1-800-211-PANA(7262)  
 or send e-mail to : consumerproducts@panasonic.com  
 or visit us at www.panasonic.com

(U.S.A)

For assistance, please call : 787-750-4300  
 or visit us at www.panasonicpr.com

(Puerto Rico)

## PRECAUTIONS TO AVOID POSSIBLE EXPOSURE TO EXCESSIVE MICROWAVE ENERGY

- (a) Do not attempt to operate this oven with the door open since open-door operation can result in harmful exposure to microwave energy. It is important not to defeat or tamper with the safety interlocks. Under normal conditions oven will not operate with door open.
- (b) Do not place any object between the oven front face and the door or allow soil or cleaner residue to accumulate on sealing surfaces.
- (c) Do not operate the oven if it is damaged. It is particularly important that the oven door close properly and that there is no damage to the:
  - (1) door (bent),
  - (2) hinges and latches (broken or loosened),
  - (3) door seals and sealing surfaces.
- (d) The oven should not be adjusted or repaired by anyone except properly qualified service personnel.

### Technical Specifications

NN-S723WL/BL	
Power Source:	120 V, 60 Hz
Power Consumption:	13.5 Amps, 1,600 W
Output*:	1,200 W
Outside Dimensions (H x W x D):	13 <sup>17</sup> / <sub>32</sub> " x 22 <sup>19</sup> / <sub>32</sub> " x 17 <sup>5</sup> / <sub>16</sub> " (344 x 573.5 x 440 mm)
Oven Cavity Dimensions (H x W x D):	10 <sup>9</sup> / <sub>32</sub> " x 16 <sup>9</sup> / <sub>16</sub> " x 16 <sup>11</sup> / <sub>16</sub> " (261 x 421 x 424 mm)
Operating Frequency:	2,450 MHz
Uncrated Weight:	Approx. 37.2 lbs. (16.9 kg)

\*IEC 60705 RATING STANDARD Specifications subject to change without notice.

The serial number of this product may be found on the back side of the oven. You should note the model number and the serial number of this oven in the space provided and retain this book as a permanent record of your purchase for future reference.

**Model No.** \_\_\_\_\_

**Serial No.** \_\_\_\_\_

**Date of Purchase** \_\_\_\_\_

## Contents

### Before Operating

Precautions .....	Inside Front Cover
Important Safety Instructions .....	4
Installation and Grounding Instructions .....	5
Safety Precautions .....	6
Cookware and Utensil Guide .....	7
Feature Diagram .....	8
Control Panel .....	8

### Operation

Clock Setting .....	9
Child Safety Lock .....	9
Quick Min Function .....	9
Power & Time Setting .....	9
Timer Setting .....	10
Popcorn Function .....	11
Auto Reheat .....	11
Auto Defrost .....	12
Auto Defrost Chart .....	13
Auto Cook .....	14
Auto Cook Chart .....	14
Food Characteristics .....	15
Cooking Techniques .....	15-16
Using Your Microwave Oven .....	17-18
Heating or Reheating Guide .....	19
Fresh Vegetable Chart .....	20
Quick Guide to Operation .....	Back Cover

### Maintenance

Technical Specifications .....	Inside Front Cover
Care of Your Microwave Oven .....	21
Before Requesting Service .....	22
Limited Warranty & Customer Services .....	23 - 24

### Manual de instrucciones (Spanish Operating Instructions)

Instrucciones de Seguridad .....	25 - 26
Instrucciones para Conexión a Tierra .....	26
Instrucciones de Instalación .....	27
Sugerencias Útiles .....	28
Panel de Control .....	29
El poder & el tiempo poniendo .....	29
Niveles de intensidad de las microondas .....	30
Trace para el cocinero automatico .....	30
Guia Rapida de Operación .....	31

# IMPORTANT SAFETY INSTRUCTIONS

Your microwave oven is a cooking device and you should use as much care as you use with a stove or any other cooking device. When using this electric appliance, basic safety precautions should be followed, including the following:

**WARNING**—To reduce the risk of burns, electric shock, fire, injury to persons, or exposure to excessive microwave energy:

1. Read all instructions before using the appliance.
2. Read and follow the specific “**PRECAUTIONS TO AVOID POSSIBLE EXPOSURE TO EXCESSIVE MICROWAVE ENERGY,**” found on the inside front cover.
3. This appliance must be grounded. Connect only to properly grounded outlet. See “**GROUNDING INSTRUCTIONS**” found on page 5.
4. Install or locate this appliance only in accordance with the installation instructions found on page 5.
5. Do not cover or block any openings on this appliance.
6. Do not store or use this appliance outdoors. Do not use this product near water—for example, near a kitchen sink, in a wet basement, or near a swimming pool, and the like.
7. Use this appliance only for its intended use as described in this manual. **DO NOT** use corrosive chemicals, vapors, or non-food products in this appliance. This type of oven is specifically designed to heat or cook. It is not designed for industrial or laboratory use. The use of corrosive chemicals in heating or cleaning will damage the appliance and may result in radiation leaks.
8. When cleaning surfaces of door and oven that come together on closing the door, use only mild, non-abrasive soaps or detergents applied with a sponge or soft cloth.
9. Do not allow children to use this appliance, unless closely supervised by an adult.
10. Do not operate this appliance if it has a damaged cord or plug, if it is not working properly, or if it has been damaged or dropped.
11. Do not immerse cord or plug in water.
12. Keep cord away from heated surfaces.
13. Do not let cord hang over edge of a table or counter.
14. This appliance should be serviced only by qualified service personnel. Contact the nearest authorized servicer for examination, repair or adjustment.
15. Some products such as whole eggs, narrow neck bottles and sealed containers—for example, closed glass jars—may explode and should not be heated in this oven.

16. To reduce the risk of fire in the oven cavity:
  - (a) Do not overcook food. Carefully attend appliance if paper, plastic, or other combustible materials are placed inside the oven to facilitate cooking.
  - (b) Remove wire twist-ties from paper or plastic bags before placing bag in oven.
  - (c) **If materials inside the oven should ignite, keep oven door closed, turn oven off, and disconnect the power cord, or shut off power at the fuse or circuit breaker panel.**
  - (d) Do not use the cavity for storage purposes. Do not leave paper products, cooking utensils, or food in the cavity when not in use.

## General Use

1. **DO NOT** tamper with or make any adjustments or repairs to door, Control Panel housing, safety interlock switches or any other part of the oven. **DO NOT** remove outer panel from oven. Repairs should only be done by a qualified service person.
2. **DO NOT** operate the oven empty. The microwave energy will reflect continuously throughout the oven causing overheating, if food or water is not present to absorb energy. This could damage the oven and result in the risk of a fire.
3. **DO NOT** dry clothes, newspapers or other materials in oven, or use newspapers or paper bags for cooking. Fire could result.
4. **DO NOT** use recycled paper products unless the paper product is labeled as safe for microwave oven use. Recycled paper products may contain impurities which may cause sparks, and result in fires when used.
5. **DO NOT** hit or strike Control Panel. Damage to controls may occur. Fire could result.
6. **POT HOLDERS** should always be used when removing items from the oven. Heat is transferred from the **HOT** food to the cooking container and from the cooking container to the Glass Tray. The Glass Tray can be very **HOT** after removing the cooking container from the oven.
7. **DO NOT** store flammable materials next to, on top of, or in the oven. These could be fire hazards.

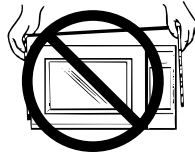

# Installation and Grounding Instructions

## Examine Your Oven

Unpack oven, remove all packing material and examine the oven for any damage such as dents, broken door latches or cracks in the door. Notify dealer immediately if oven is damaged. **DO NOT** install if oven is damaged.

## Placement of Oven

1. Oven must be placed on a flat, stable surface. For proper operation, the oven must have sufficient air flow. Allow 4-inches (10 cm) of space on both sides and top of oven.
  - a. **DO NOT** block air vents. If they are blocked during operation, the oven may be overheated and damaged. When using any cloth over the oven, the air intake and exhaust should not be blocked. Also should allow space on back and both sides of oven properly.
  - b. **DO NOT** place oven near a hot, damp surface such as a gas or electric range, or dishwasher.
  - c. **DO NOT** operate oven when room humidity is too high.
2. This oven was manufactured for household use only.

## Grounding Instructions

**This appliance must be grounded.** In the event of an electrical short circuit, grounding reduces the risk of electric shock by providing an escape wire for the electric current. This appliance is equipped with a cord having a grounding wire with a grounding plug. The plug must be plugged into an outlet that is properly installed and grounded.

**WARNING—Improper use of the grounding plug can result in a risk of electric shock.**

Consult a qualified electrician or service person if the grounding instructions are not completely understood, or if doubt exists as to whether the appliance is properly grounded. If it is necessary to use an extension cord, use only a three wire extension cord that has a three blade grounding plug, and a three slot receptacle that will accept the plug on the appliance. The marked rating of the extension cord should be equal to or greater than the electrical rating of the appliance.

## Power Supply

1. A short power-supply cord is provided to reduce the risks resulting from becoming entangled in or tripping over a longer cord.
2. Longer cord sets or extension cords are available and may be used if care is exercised in their use.
3. If a long cord or extension cord is used, (1) the marked electrical rating of the cord set or extension cord should be at least as great as the electrical rating of the appliance, (2) the extension cord must be a grounding-type 3-wire cord, and (3) the longer cord should be arranged so that it will not drape over the counter top or tabletop where it can be pulled on by children or tripped over accidentally.

## Wiring Requirements

1. The oven must be on a **SEPARATE CIRCUIT**. No other appliance should share the circuit with the microwave oven. If it does, the branch circuit fuse may blow, the circuit breaker may trip, or the food may cook slower than the times recommended in this manual.
2. The **VOLTAGE** used must be the same as specified on this microwave oven (120 V, 60 Hz). Using a higher voltage is dangerous and may result in a fire or other incident causing oven damage. Using a lower voltage will cause slow cooking. Panasonic is **NOT** responsible for damage resulting from the use of the oven with other than the specified voltage.
3. The oven must be plugged into at least a **20 AMP, 120 VOLT, 60 Hz GROUNDED OUTLET**. Where a standard two-prong outlet is encountered, it is the personal responsibility and obligation of the consumer to have it replaced with a properly grounded three-prong outlet.

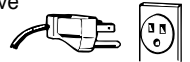

## TV / Radio Interference

1. Operation of the microwave oven may cause interference to your radio, TV or similar equipment.
2. When there is interference, it may be reduced or eliminated by taking the following measures:
  - a. Clean door and sealing surfaces of the oven. (See Care of Your Microwave Oven)
  - b. Place the radio, TV, etc. away from the microwave oven as far as possible.
  - c. Use a properly installed antenna to obtain stronger signal reception.

## Glass Tray

1. **DO NOT** operate the oven without Rotating Ring and Glass Tray in place.
2. **DO NOT** operate the oven without the Glass Tray fully engaged on the drive hub. Improper cooking or damage to the oven could result. Verify that the Glass Tray is properly engaged and rotating by observing its rotation when you press **Start**.
3. Only use the Glass Tray specifically designed for this oven. Do not substitute any other glass tray.
4. If the Glass Tray is hot, allow to cool before cleaning or placing in water.
5. **DO NOT** cook directly on the Glass Tray. Always place food in a microwave-safe dish, or on a rack set in a microwave-safe dish.
6. If food or utensil on Glass Tray touches oven walls, causing the tray to stop moving, the tray will automatically rotate in the opposite direction. This is normal.
7. Glass Tray can turn in either direction.

## Rotating Ring

1. Rotating Ring and oven floor should be cleaned frequently to prevent excessive noise.
2. Rotating Ring must always be used for cooking along with Glass Tray.
3. Always replace Rotating Ring and Glass Tray in their proper positions.

# SAVE THESE INSTRUCTIONS

For proper use of your oven read remaining safety cautions and operating instructions.

## Safety Precautions

### Follow These Safety Precautions When Cooking in Your Oven

#### **IMPORTANT**

Proper cooking depends upon the power, the time set and the quantity of food. If you use a smaller portion than recommended and cook at the time for the recommended portion, fire can result.

#### 1) HOME CANNING / DRYING FOODS / SMALL QUANTITIES OF FOODS

- **DO NOT** use your oven for home canning, your oven cannot maintain the food at the proper canning temperature. Improperly canned food may spoil and be dangerous to consume.
- **DO NOT** dry meats, herbs, fruits or vegetables in your oven. Small quantities of food or foods with low moisture content can dry out, scorch or catch on fire if overheated.

#### 2) POPCORN

Popcorn may be popped in a microwave oven corn popper. Microwave popcorn which pops in its own package is also available. Follow popcorn manufacturers' directions and use a brand suitable for the wattage of your microwave oven.

**CAUTION: When using pre-packaged microwave popcorn, follow recommended package instructions. Check package weight before using the Popcorn pad (see Popcorn Pad section). Set the oven for the weight of the popcorn package.**

**If these instructions are not followed, the popcorn may not pop adequately or may ignite and cause a fire. Never leave oven unattended when popping popcorn. Allow the popcorn bag to cool before opening, always open the bag away from your face and body to prevent steam burns.**

#### 3) DEEP FAT FRYING

- **DO NOT** attempt to deep fat fry in your microwave oven. Cooking oils may burst into flames and may cause damage to the oven and perhaps result in burns. Microwave utensils may not be able to withstand the temperature of the hot oil, and could shatter or melt.

#### 4) FOODS WITH NONPOROUS SKINS

- **Potatoes, apples, whole eggs, egg yolks, whole squash and sausages are examples of foods with nonporous skins.** These types of foods must be pierced before microwave cooking to prevent their bursting.
- Use fresh potatoes for baking and cook until just done. Use recommended weights for programmed cooking. Overcooking causes dehydration and may result in a fire.

#### 5) LIQUIDS

- Liquids can become "superheated" in a microwave, and when the container is moved in any way, the **superheated liquids can "explode" out of the container.** "Superheated" water is hotter than boiling water, **EVEN THOUGH IT DOES NOT APPEAR TO BUBBLE.** To reduce the possibility

of this occurrence:

**Always make sure that liquids are stirred vigorously** before heating to assure that the liquid is mixed with air. **NEVER HEAT LIQUIDS FOR AN EXCESSIVE LENGTH OF TIME.**

#### 6) GLASS TRAY / COOKING UTENSILS / FOIL

- Cooking utensils get hot during microwaving. Heat is transferred from the HOT food to the container and the Glass Tray. Use potholders when removing utensils from the oven or when removing lids or plastic wrap covers from cooking utensils to avoid burns.
- The Glass Tray will get hot during cooking. It should be allowed to cool before handling or before paper products, such as paper plates or microwave popcorn bags, are placed in the oven for microwave cooking.

- When using foil, skewers, warming rack or utensils made of metal in the oven, allow at least 1-inch (2.5 cm) of space between metal material and interior oven walls. If arcing occurs (sparking), remove metal material (skewers etc.) and/or transfer to a non-metallic container.

- Dishes with metallic trim should **not** be used, as arcing may occur.

- If an entree is heated in a foil tray, maintain at least 1-inch (2.5 cm) spacing from the oven walls.

#### 7) PAPER TOWELS / CLOTHS

- **DO NOT** use paper towels or cloths which contain a synthetic fiber woven into them. The synthetic fiber may cause the towel to ignite. Use paper toweling under supervision.

#### 8) BROWNING DISHES / OVEN COOKING BAGS

- Browning dishes or grills are designed for microwave cooking only. Always follow instructions provided by the manufacturer. **DO NOT** preheat browning dish more than 6 minutes.
- If an oven cooking bag is used for microwave cooking, prepare according to package directions. **DO NOT** use a wire twist-tie to close bag, instead use plastic ties, cotton string or a strip cut from the open end of the bag.

#### 9) THERMOMETERS

- **DO NOT** use a conventional meat thermometer in your oven. Arcing may occur. Microwave-safe thermometers are available for both meat and candy.

#### 10) BABY FORMULA / FOOD

- **DO NOT** heat baby formula or food in the microwave oven. The glass jar or surface of the food may appear to be only warm while the interior can be so hot as to burn the infant's mouth and esophagus.

#### 11) REHEATING PASTRY PRODUCTS

- When reheating pastry products, check temperatures of any fillings before eating. Some foods have fillings which heat faster and can be extremely hot, while the surface remains warm to the touch (ex. Jelly Donuts).

#### 12) GENERAL OVEN USAGE GUIDELINES

- **DO NOT** use the oven for any reason other than the preparation of food.
- **DO NOT** leave oven unattended while in use.

## Cookware and Utensil Guide

ITEM	MICROWAVE	COMMENTS
Aluminum Foil	Yes for Shielding only	Small strips of foil can be molded around thin parts of meat or poultry to prevent overcooking. Arcing can occur if foil is too close to oven wall or if too much foil is used.
Browning Dish	Yes	Browning dishes are designed for microwave cooking only. Check browning dish information for instructions and heating chart. Do not preheat for more than 6 minutes.
Brown paper bags	No	May cause a fire in the oven.
Dinnerware Labeled "Microwave-Safe"	Yes	Check manufacturers' use and care directions for use in microwave heating. Some dinnerware may state on the back of the dish, "Oven-Microwave Safe".
Other Dinnerware	?	Use <b>CONTAINER TEST</b> below.
Disposable polyester Paperboard Dishes	Yes	Some frozen foods are packaged in these dishes. Can be purchased in grocery stores.
Fast Food Carton with Metal Handle	No	Metal handle may cause arcing.
Frozen Dinner Tray Metal	Yes	Frozen dinners may be heated in foil tray, if tray is less than 3/4-in. (2 cm) high. Place foil tray in center of oven. Leave at least 1-in. (2.5 cm) space between foil tray and oven walls. Heat only 1 foil tray in the oven at a time. For containers more than 3/4-inch (2 cm) deep, remove food and place in a similar size microwave-safe container.
Microwave-safe	Yes	
Glass Jars	Yes, use caution	Remove lid. Heat food until just warm, not HOT. Most glass jars are not heat resistant. Do not use for cooking.
Glassware Heat Resistant Oven Glassware & Ceramics	Yes	Ideal for microwave cooking and browning. (See <b>CONTAINER TEST</b> below)
Metal Bakeware	No	Not recommended for use in microwave ovens.
Metal Twist-Ties	No	May cause arcing which could cause a fire in the oven.
Oven Cooking Bag	Yes	Follow manufacturers' directions. Close bag with the nylon tie provided, a strip cut from the end of the bag, or a piece of cotton string. Do not close with a metal twist-tie. Make six 1/2-in. (1 cm) slits near the closure.
Paper Plates & Cups	Yes	Use to warm cooked foods, and to cook foods that require short cooking times such as hot dogs.
Paper Towels & Napkins	Yes	Use to warm rolls and sandwiches by microwave.
Parchment Paper	Yes	Use as a cover to prevent spattering. Safe for use in microwave, microwave/convection and conventional ovens.
Plastic Microwave-Safe Cookware	Yes	Should be labeled, "Suitable for Microwave Heating." Check manufacturers' directions for recommended uses.
Reheat & Storage	Yes, use caution	Some microwave-safe plastic dishes are not suitable for cooking foods with high fat or sugar content. The heat from hot food may cause the plastic to warp.
Melamine	No	This material absorbs microwave energy. Dishes get HOT!
Plastic Foam Cups	Yes, use caution	Plastic foam will melt if foods reach a high temperature. Use to bring foods to a low serving temperature.
Plastic Wrap	Yes	Use to cover food during cooking to retain moisture and prevent spattering. Should be labeled "Suitable for Microwave Heating". Check package directions.
Straw, Wicker, Wood	Yes	Use only for short term reheating and to bring food to a low serving temperature.
Thermometers Microwave-safe, only	Yes	Use only microwave-safe meat and candy thermometers. Not suitable for use in microwave oven, will cause sparks and get hot.
Conventional	No	
Wax paper	Yes	Use as a cover to prevent spattering and to retain moisture.

### CONTAINER TEST

**TO TEST A CONTAINER FOR SAFE MICROWAVE OVEN USE:** Fill a 1-cup glass measure with water and place it in the microwave oven along with the container to be tested; **heat one (1) minute at P10 (HIGH).** If the container is microwave oven-safe (transparent to microwave energy), the container should remain comfortably cool and the water should be hot. If the container is hot, it has absorbed some microwave energy and should NOT be used. This test cannot be used for plastic containers.

## Feature Diagram

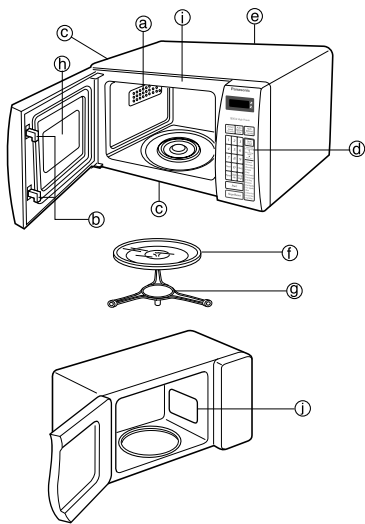

- (a) Internal Air Vents
- (b) Door Safety Lock System
- (c) External Air Vents
- (d) Control Panel
- (e) Identification Plate
- (f) Glass Tray
- (g) Rotating Ring
- (h) Heat/Vapor Barrier Film (do not remove)
- (i) Menu Label
- (j) Cover (do not remove)

## Control Panel

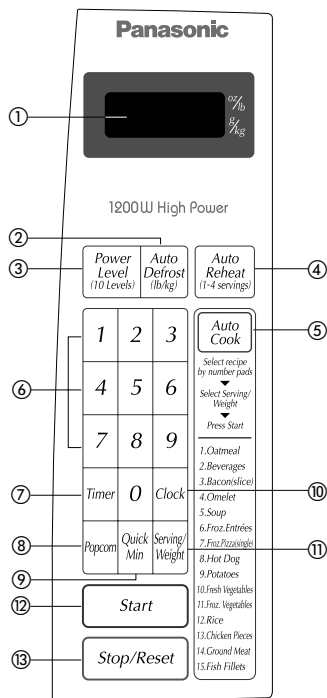

1. DISPLAY WINDOW.
2. AUTO DEFROST PAD (Page 12)
3. POWER LEVEL PAD (Page 9)
4. AUTO REHEAT PAD (Page 11)
5. AUTO COOK PAD (Page 14)
6. NUMBER PAD
7. TIMER PAD (Page 10)
8. POPCORN PAD (Page 11)
9. QUICK MIN PAD (Page 9)
10. CLOCK PAD (Page 9)
11. SERVING/WEIGHT PAD (Page 14)
12. START PAD.  
One tap allows oven to begin functioning. If door is opened or STOP/RESET pad must be pressed again to restart oven.
13. STOP/RESET PAD.  
Before cooking: One tap clears your instruction. During cooking: One tap temporarily stops the cooking process. Another tap cancels all your instructions and time of day or colon appears on the Display Window.

### Beep Sound:

When a pad is pressed correctly, a beep will be heard. If a pad is pressed and no beep is heard, the unit did not or cannot accept the instruction. The oven will beep twice between programmed stages. At the end of any complete program, the oven will beep.

## Clock Setting

The oven will operate without setting the clock.

**Example: To set 11:25 a.m. or p.m.**

1.		• Press once. ▶Colon flashes.
2.		• Enter time of day using the number pads. ▶Time appears on the Display Window: Colon continues flashing.
3.		• Press. ▶Colon stops flashing; time of day is entered.

### NOTES:

1. To reset the clock, repeat steps 1-3.
2. The clock will keep the time of day as long as the oven is plugged in and electricity is supplied.
3. Clock is a 12 hour display.
4. Oven will not operate while colon is flashing.

## Child Safety Lock

You can use this safety feature to lock the control panel so that children cannot use the oven when you do not want them.

**To set CHILD SAFETY LOCK:**

1.		• Hold until "L" appears from the display.
----	--	--

**To cancel CHILD SAFETY LOCK:**

1.		• Hold until "L" disappears from the display.
----	--	---

## Quick Min Function

This feature allows you to set and/or add cooking times easily in multiples of one minute.

**To set Standing Time:**

1.		• Set cooking time (up to 10 taps/minutes)
2.		• Press <b>Start</b> Pad. ▶Cooking will start on P10(HIGH) power.

### NOTES:

1. You can use other power levels, select desired power level before setting cooking time.
2. After setting the time by **Quick Min** Pad, you cannot use Number Pads, and vice versa.
3. Press **Quick Min** Pad to add more time during cooking. To verify the additional cooking time, check the **Display Window**.

## Power & Time Setting

How do I program Power and Time?

**Example: To cook at P6 (MEDIUM) Power for 1 minute 30 seconds.**

1.		• Select <b>Power Level</b> . (according to the chart below)
2.		• Set Cooking Time using number pads.
3.		• Press. ▶Cooking will start. The time on the screen will count down.

Press	Power Level
once	P10 (HIGH)
twice	P 9
3 times	P 8
4 times	P 7 (MEDIUM-HIGH)
5 times	P 6 (MEDIUM)
6 times	P 5
7 times	P 4
8 times	P 3 (MEDIUM-LOW)/DEFROST
9 times	P 2
10 times	P 1 (LOW)

### NOTES:

1. For more than one stage cooking, repeat steps 1 and 2 for each stage of cooking before pressing **Start** Pad.
2. When selecting P10 (HIGH) power for the first stage, you may begin at step 2.
3. Two beeps will sound between each stage of programming. Five beeps will sound at the end of the entire sequence.
4. When selecting P10 (HIGH) power, the maximum programmable time is 30 minutes. For other power levels, the maximum time is 99 minutes and 99 seconds.
5. For reheating, use P10 (HIGH) for liquids, P7 (MEDIUM-HIGH) for most foods and P6 (MEDIUM) for dense foods.
6. For defrosting, use P3 (MEDIUM-LOW).

## Timer Setting

This feature allows you to program a Standing Time after cooking is completed and to program the oven as a minute timer and/or to program a delay start.

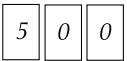
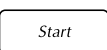

### To Use as a Kitchen Timer:

**Example: To count 5 minutes**

1. 	• Press.
2. 	• Set desired amount of time using number pads. (up to 99 minutes and 99 seconds.)
3. 	• Press. ➤ Time will count down without oven operating.

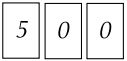

### To Set Delay Start:

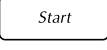
**Example: To start cooking 5 minutes later. (3 mins. at MEDIUM Power.)**

1. 	• Press once.
2. 	• Enter desired amount of delayed time using number pads. (up to 99 minutes and 99 seconds.)
3.  5 times 	• Enter the desired cooking program (see page 9 for directions)
4. 	• Press. ➤ Delayed time will count down. Then cooking will start.

### To Set Stand Time:

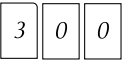
**Example: To stand for 5 mins. after cooking (3 mins. at MEDIUM Power)**

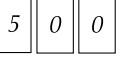
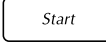
1.  5 times 	• Enter the desired cooking program (see page 9 for directions)
2. 	• Press once.
3. 	• Set desired amount of Stand Time using number pads. (up to 99 minutes and 99 seconds.)
4. 	• Press. ➤ Cooking will start. After cooking, stand time will count down without oven operating.

### NOTES:



1. If oven door is opened during Stand Time or Kitchen Timer, the time on the screen will continue to count down.
2. Stand Time and Delay time cannot be programmed before any Auto Control Function. This is to prevent the starting temperature of food from rising before defrosting or cooking begins. A change in starting temperature could cause inaccurate results.

## Popcorn Function

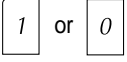
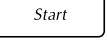

**Example: To heat 1.75 oz. of Popcorn**

1. 	• Set the desired weight of prepackaged microwave popcorn.								
	<table border="1"> <tr> <th>Press</th> <th>Weight</th> </tr> <tr> <td>once</td> <td>1.75 oz. (50g)</td> </tr> <tr> <td>twice</td> <td>3.0 oz. (85g)</td> </tr> <tr> <td>3 times</td> <td>3.5 oz. (99g)</td> </tr> </table>	Press	Weight	once	1.75 oz. (50g)	twice	3.0 oz. (85g)	3 times	3.5 oz. (99g)
Press	Weight								
once	1.75 oz. (50g)								
twice	3.0 oz. (85g)								
3 times	3.5 oz. (99g)								
2.  Optional									
3. 	• Press <b>Start</b> Pad. ➤ Cooking time appears in the display and begins to count down.								

### Ingenious Use by or

When using popcorn pad, maybe the weight is not the same as offered. By using the number pads  or , the programs can be adjusted to cook for a heavier or lighter weight.

To control by  or  pad:

 Press	1 tap= More <sup>+</sup> 2 taps= More <sup>++</sup>
 Press	1 tap= Less <sup>-</sup> 2 taps= Less <sup>--</sup>

## Auto Reheat

This feature allows you to reheat 1 to 4 servings of precooked room temperature and refrigerator temperature foods without setting power and time.

**Example: To reheat 2 cups of soup**

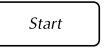
1.  Press twice	• Press until the desired number of servings appears in the <b>Display Window</b> .
2. 	• Press. ➤ Cooking time appears in the <b>Display Window</b> and begins to count down.

Press Auto Reheat pad to indicate number or servings	Average Serving Size
once	4-6 oz.
twice	8 oz.
three times	12 oz.
four times	16 oz.

**NOTES:** For best results, follow these recommendations:

1. All foods must be previously cooked.
2. Foods should always be covered loosely with plastic wrap, wax paper or casserole lid.
3. All foods should have a covered stand time of 3 to 5 minutes.
4. **DO NOT** reheat bread and pastry products using **Auto Reheat** Use manual power and time instead.
5. **DO NOT** reheat beverages.
6. Times are based on an approximate serving size of 4 oz.
7. A plate of food is normally 3-4 servings.

## Auto Defrost

AUTO DEFROST thaws frozen food without entering a cook time or cook power. Three defrost categories are preset in your oven: Ground Meat, Poultry, and Steaks/Chops. See the Auto Defrost Chart on the next page.

### NOTES:

- For added convenience, AUTO DEFROST has a built-in reminder tone to tell you when to check, turn over, separate, or rearrange food. The oven will sound a tone during the defrost cycle. At the tone, open the door and turn, separate, or rearrange food. Remove any portion that have thawed. Return frozen portion to the oven and touch START to resume the defrost cycle.
- You can defrost foods that weight 0.1 to 6.0 lbs (0.1 to 4.0 kg).

### For best results:

- Remove fish, shellfish, meat, and poultry from its original closed paper or plastic package (wrapper). Otherwise, the wrap will hold steam and juice close to the foods, which can cause the outer surface of the foods to cook.
- Shape ground meat into the form of a doughnut before freezing. When defrosting, remove thawed meat when the reminder tone sounds and continue defrosting.
- Place foods in a shallow container or on a microwave roasting rack to catch drippings.
- Food should still be somewhat icy in the center when removed from the oven.

To choose the unit of weight (oz/lb or g/kg).

- You can choose the unit of weight when you plug in a oven.
- If you don't select a unit when you just plug in a oven, the oven will be selected to "oz/lb".

oz/lb



g/kg



Touch the "start" pad

**Example: To defrost 1.2 lbs. of ground beef.**

<b>1.</b>		• once for Meat.
<b>2.</b>		• to enter 1.2 lbs.
<b>3.</b>		• Press. ▶ To start the oven. (Time counting down.)
<b>4.</b>	At the end of the defrost time, five short tones will sound. The oven will stop.	



## AUTO DEFROST CHART

Category	Touch keypad	Food to be Defrosted	At Reminder Tone	Standing Time		
<b>GROUND MEAT (dEF1)</b>	<b>once</b>	<b>Beef</b> Ground beef	Turn over. Remove thawed portions and break apart. Return remainder to oven.	5 min.		
		Cubes for stew	Turn over. Remove thawed portions with fork.	5 min.		
		Hamburger patties Pot roast	Turn over. Turn over. Cover warm areas with aluminum foil.	5 min. 10-20 min.		
		Rib roast, Rump roast, Chuck roast	Same as above.	10-20 min. 10-20 min.		
		<b>Pork</b> Bacon, Hot dogs Sausage links Sausage patties Ribs, Roast	Turn over. Turn over. Turn over. Turn over. Cover warm areas with aluminum foil.	2 min. 5 min. 5 min. 10-20 min.		
		<b>Lamb</b> Ribs	Turn over. Cover warm areas with aluminum foil.	10-20 min.		
		Roasts	Same as above.	10-20 min.		
		<b>POULTRY (dEF2)</b>	<b>twice</b>	<b>Poultry</b> Whole Chicken	Turn over. Finish defrosting breast-side down. Cover warm areas with aluminum foil.	10-20 min. Rinse under cold running water.
				Chicken Pieces Cornish Hens: Whole, Split	Separate pieces and rearrange. Turn over. Cover warm areas with aluminum foil.	5-10 min. 10-20 min. Rinse under cold running water.
				<b>Turkey</b> Breast (under 6 lbs.)	Turn over and arrange.	10-20 min. Rinse under cold running water.
<b>STEAKS/ CHOPS (dEF3)</b>	<b>3 times</b>	<b>Beef Steaks</b>	Turn over. Cover warm areas with aluminum foil.	10-20 min.		
		<b>Pork Chops</b> <b>Lamp Chops</b>	Same as above. Same as above.	10-20 min. 10-20 min.		
		<b>Fish</b>  Steaks, whole fish fillets	Turn over and rearrange. Cover head and tail with foil. Turn over. Separate fillets when partially thawed if possible.	5 min. 5 min. Rinse with cold water to separate.		
		<b>Shellfish</b> Crabmeat, Shrimp Lobster tails Scallops	Rearrange and break apart. Turn over and rearrange. Turn over and rearrange.	5 min. 5 min. 5 min.		

## Auto Cook

Use this function to cook food without entering a cook time or power. Refer to the Auto Cook Chart below for more information.

**Example: To cook a 10 oz. Frozen Entrée**

1.		• Press.
2.		• Select the desired category number using the number pads.

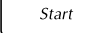
3.		• Press until the desired quantity appears on the <b>Display Window</b> .
4.		• Press. ▶Cooking time appears in the <b>Display Window</b> and begins to count down.

## AUTO COOK CHART

Pad	Serving/Weight	Hints
1. Oatmeal	1/2, 1 cup	Put amount of oatmeal in a microwave-safe cup and add water according to the manufacturers' directions. No cover. Stir thoroughly after heating.
2. Beverages	1, 2 cups	Use mug or microwave-safe cup with no cover. Stir after reheating.
3. Bacon (slice)	4, 6, 10 slices	Place slices of bacon on a 3 sheet of paper towel on microwave-safe dish. Cover with paper towel. If bacon is not cooked to your liking, continue to heat by manually adding more time.
4. Omelet	2, 4 eggs	< Ingredients for 2 eggs > 1 tablespoon butter or margarine 2 tablespoons milk salt and ground black pepper Melt butter in a 9-inch pie plate, turn the plate to coat the bottom with butter. Combine the remaining ingredients and pour into the pie plate and cover with vented plastic wrap. Let stand 2 minutes. With a spatula, loosen the edges of the omelet from the plate; fold into thirds to serve.
5. Soup	1, 2 cups	Pour soup into a microwave-safe bowl. Cover loosely with lid or vented plastic wrap. Stir after reheating.
6. Frozen Entrees	10, 20 oz.	Follow manufacturers' directions for covering.
7. Frozen Pizza (single)	4, 8 oz.	Follow manufacturers' directions.
8. Hot Dog	1, 2, 3, 4 pieces	Make slits on hot dogs and place on paper towels.
9. Potatoes	1, 2, 3, 4 pieces	Pierce skin with a fork and place potatoes on paper Towel. Do not cover. Stand 5 minutes after cooking.
10. Fresh Vegetables	4, 8, 12, 16 oz.	All pieces should be the same size. Add small amount of water and cover with lid or plastic wrap.
11. Frozen Vegetables	6, 10, 16 oz.	Add small amount of water and cover with lid or vented plastic wrap. Stir thoroughly at beep for even cooking.
12. Rice	1/2, 1, 1 1/2 cups	Add double amount of hot water and cover with plastic wrap.
13. Chicken Pieces	6, 12, 18, 24 oz.	Place chicken pieces with skin side up and cover with plastic wrap.
14. Ground Meat	16, 32 oz.	Cover with plastic wrap. Stir thoroughly at beep for even cooking
15. Fish Fillets	4, 8, 12, 16 oz.	Place fish fillets in a single layer and cover with plastic wrap.

## Food Characteristics

### Bone and Fat

Both bone and fat affect cooking. Bones may cause irregular cooking. Meat next to the tips of bones may overcook while meat positioned under a large bone, such as a ham bone, may be undercooked. Large amounts of fat absorb microwave energy and the meat next to these areas may overcook.

### Density

Porous, airy foods such as breads, cakes or rolls take less time to cook than heavy, dense foods such as potatoes and roasts. When reheating donuts or other foods with different centers be very careful. Certain foods have centers made with sugar, water or fat and these centers attract microwaves (For ex., jelly donuts). When a jelly donut is heated, the jelly can become extremely hot while the exterior remains warm to the touch. This could result in a burn if the food is not allowed to cool properly in the center.

### Quantity

Two potatoes take longer to cook than one potato. As the quantity of the food increases so does the cooking time. When cooking small amounts of food such as one or two potatoes, do not leave oven unattended. The moisture content in the food may decrease and a fire could result.

### Shape

Uniform sizes heat more evenly. The thin end of a drumstick will cook more quickly than the meaty end. To compensate for irregular shapes, place thin parts toward the center of the dish and thick pieces toward the edge.

### Size

Thin pieces cook more quickly than thick pieces.

### Starting Temperature

Foods that are room temperature take less time to cook than if they are chilled or refrigerated or frozen.

## Cooking Techniques

### Piercing



Foods with skins or membranes must be pierced scored or have a strip of skin peeled before cooking to allow steam to escape. Pierce whole egg yolks and whites, clams, oysters, chicken livers, whole potatoes and whole vegetables. Whole apples or new potatoes should have a 1-inch strip of skin peeled before cooking. Score sausages and frankfurters.

### Browning



Foods will not have the same brown appearance as conventionally cooked foods or those foods which are cooked utilizing a browning feature. Meats and poultry may be coated with browning sauce, Worcestershire sauce, barbecue sauce or shake-on browning sauce. To use, combine browning sauce with melted butter or margarine; brush on before cooking. For quick breads or muffins, brown sugar can be used in the recipe in place of granulated sugar, or the surface can be sprinkled with dark spices before baking.



## Cooking Techniques

### Spacing



Individual foods, such as baked potatoes, cupcakes and appetizers, will cook more evenly if placed in the oven equal distances apart. When possible, arrange foods in a circular pattern.

### Covering



As with conventional cooking, moisture evaporates during microwave cooking. Casserole lids or plastic wrap are used for a tighter seal. When using plastic wrap, vent the plastic wrap by folding back part of the plastic wrap from the edge of the dish to allow steam to escape. Loosen or remove plastic wrap as recipe directs for stand time. When removing plastic wrap covers, as well as any glass lids, be careful to remove them away from you to avoid steam burns. Various degrees of moisture retention are also obtained by using wax paper or paper towels. However, unless specified, a recipe is cooked covered.

## Cooking Techniques

### Shielding

Thin areas of meat and poultry cook more quickly than meaty portions. To prevent overcooking, these thin areas can be shielded with strips of aluminum foil. Wooden toothpicks may be used to hold the foil in place.

### Timing

A range in cooking time is given in each recipe. The time range compensates for the uncontrollable differences in food shapes, starting temperature and regional preferences. Always cook food for the minimum cooking time given in a recipe and check for doneness. If the food is undercooked, continue cooking. It is easier to add time to an undercooked product. Once the food is overcooked, nothing can be done.

### Stirring

Stirring is usually necessary during microwave cooking. We have noted when stirring is helpful, using the words once, twice, frequently or occasionally to describe the amount of stirring necessary. Always bring the cooked outside edges toward the center and the less cooked center portions toward the outside of the dish.

### Rearranging

Rearrange small items such as chicken pieces, shrimp, hamburger patties or pork chops. Rearrange pieces from the edge to the center and pieces from the center to the edge of the dish.

### Turning

It is not possible to stir some foods to redistribute the heat. At times, microwave energy will concentrate in one area of a food. To help insure even cooking, these foods need to be turned. Turn over large foods, such as roasts or turkeys, halfway through cooking.

### Stand Time

Most foods will continue to cook by conduction after the microwave oven is turned off. In meat cookery, the internal temperature will rise 5°F to 15°F (3°C to 8°C), if allowed to stand, tented with foil, for 10 to 15 minutes. Casseroles and vegetables need a shorter amount of standing time, but this standing time is necessary to allow foods to complete cooking to the center without overcooking on the edges.

### Testing Doneness

The same tests for doneness used in conventional cooking may be used for microwave cooking. Meat is done when fork-tender or splits at fibers. Chicken is done when juices are clear yellow and drumstick moves freely. Fish is done when it flakes and is opaque. Cake is done when a toothpick or cake tester is inserted and comes out clean. Candy is done when it reaches the proper temperature for each stage of crystallization.

## Using Your Microwave Oven

**WARNING: Do not use aluminum foil during cooking cycle.**

### COOKING TIPS

#### Meat

1. No special techniques are required. Meat should be prepared as with conventional cooking. Season if desired. Always thoroughly defrost meat before cooking.
2. Place the meat on a microwave roasting rack or microwave-proof plate and place on the turntable.
3. Cook according to the Meat Cooking Chart (below). Use the longer time for large meats and the shorter time for smaller meats. For thicker chops, use the longer time.
4. Turn the meat once halfway through the cooking time.
5. **Let stand** for 5-10 minutes wrapped in foil after cooking. The standing time is very important as it completes the cooking process.
6. Make sure meat, especially pork, is thoroughly cooked before eating.

### Meat Cooking Chart

Meat	Microwave Power	Cooking Time Per Pound
<b>BEEF</b>		
Standing/Rolled Rib		
– Rare	8	7 to 9 minutes
– Medium	8	8 to 10 minutes
– Well-done	8	9 to 12 minutes
Ground Beef (to brown for casserole)	HIGH(100%)	5 to 7 minutes
Hamburgers, Fresh or defrosted (4 oz. each)		
– 2 patties	HIGH(100%)	1 to 3 minutes
– 4 patties	HIGH(100%)	2 to 4 minutes
<b>PORK</b>		
Loin, Leg Bacon	8	9 to 14 minutes
– 4 slices	HIGH(100%)	2 to 4 minutes
– 6 slices	HIGH(100%)	3 to 5 minutes

**NOTE:** The times listed above are only a guide. Allow for difference in individual tastes and preferences. The times may also vary due to the shape, cut, and composition of the food.

#### Poultry

1. No special techniques are required. Poultry should be prepared as with conventional cooking. Season if desired.
2. Poultry should be thoroughly defrosted. Remove giblets and any metal clamps.
3. Prick the skin and brush lightly with vegetable oil unless the poultry is self-basting.
4. All poultry should be placed on a microwave roasting rack or a microwave-proof plate and placed on the turntable.
5. Cook according to the instructions in the Poultry Cooking Chart below. Turn over halfway through the cooking time. Because of its shape, poultry has a tendency to cook unevenly, especially in very bony parts. Turning during roasting helps to cook these areas evenly.
6. **Let stand** for 5-10 minutes wrapped in foil after cooking before carving. The standing time is very important, as it completes the cooking process.
7. Make sure poultry is thoroughly cooked before eating. Whole poultry is completely cooked when the juices run clear from the inside thigh when it is pierced with a sharp knife. Poultry pieces should be pierced with a sharp knife through the thickest part to ensure that the juices are clear and the flesh is firm.

### Poultry Cooking Chart

Poultry	Microwave Power	Cooking Time Per Pound
<b>CHICKEN</b>		
Whole	8	6 to 9 minutes
Breast (boned)	8	5 to 7 minutes
Portions	8	5 to 7 minutes
<b>TURKEY</b>		
Whole	8	6 to 9 minutes

#### NOTES:

- The times listed above are only a guide. Allow for difference in individual tastes and preferences. The times may also vary due to the shape, cut, and composition of the food.
- If whole poultry is stuffed, the weight of the stuffed bird should be used when calculating the cooking time.

## Using Your Microwave Oven

### COOKING TIPS (continued)

#### Fish

1. Arrange fish in a large shallow non-metallic dish or casserole.
2. Cover with pierced microwave plastic wrap or casserole lid.
3. Place the dish on the turntable.
4. Cook according to the instructions in the Fresh Fish Cooking Chart below. Flakes of butter can be added to the fish if desired.
5. Let stand as directed in the Cooking Chart before serving.
6. After standing time, check to see that the fish is thoroughly cooked. The fish should be opaque and flake easily.

### Fresh Fish Cooking Chart

Fish	Power	Cooking Time Per Pound	Method	Standing Time
Fish Fillets	HIGH	3 to 5 minutes	Add 15 to 30 ml (1 to 2 tbsp.) lemon juice	2 to 3 minutes
Whole Mackerel, Cleaned and Prepared	HIGH	3 to 5 minutes	—	3 to 4 minutes
Whole Trout, Cleaned and Prepared	HIGH	4 to 6 minutes	—	3 to 4 minutes
Salmon Steaks	HIGH	3 to 6 minutes	Add 15 to 30 ml (1 to 2 tbsp.) lemon juice	3 to 4 minutes

## Heating or Reheating Guide

To heat or reheat successfully in the microwave, it is important to follow several guidelines. Measure the amount of food in order to determine the time needed to reheat. Arrange the food in a circular pattern for best results. Room temperature food will heat faster than refrigerated food. Canned foods should be taken out of the can and placed in a microwavable container. The food will be heated more evenly if covered with a microwavable lid or plastic wrap and vented. Remove cover carefully to prevent steam burns. Use the following chart as a guide for reheating cooked food.

Items	Cook time (at HIGH)	Special Instructions
Sliced meat 3 slices (1/4-inch thick)	1-2 minutes	Place sliced meat on microwavable plate. Cover with plastic wrap and vent. * Note: Gravy or sauce helps to keep meat juicy.
Chicken pieces 1 breast	2-3 minutes	Place chicken pieces on microwavable plate. Cover with plastic wrap and vent.
1 leg and thigh	2-3 minutes	
Fish fillet (6-8 oz.)	1-2 1/2 minutes	Place fish on microwavable plate. Cover with plastic wrap and vent.
Lasagna 1 serving (10 1/2 oz.)	4-6 minutes	Place lasagna on microwavable plate. Cover with plastic wrap and vent.
Casserole 1 cup	1-3 minutes	COOK covered in microwavable casserole. Stir once halfway through cooking.
4 cups	4-7 minutes	
Casserole – cream or cheese 1 cup	1-3 minutes	COOK covered in microwavable casserole. Stir once halfway through cooking.
4 cups	2-4 minutes	
Sloppy Joe or Barbecued beef 1 sandwich (1/2 cup meat filling) without bun	1 -2 minutes	Reheat filling and bun separately. Cook filling covered in microwavable casserole. Stir once. Heat bun as directed in chart below.
Mashed potatoes 1 cup	1-3 minutes	COOK covered in microwavable casserole. Stir once halfway through cooking.
4 cups	5-8 minutes	
Baked beans 1 cup	1-3 minutes	COOK covered in microwavable casse role. Stir once halfway through cooking.
Ravioli or pasta in sauce 1 cup	2-3 minutes	COOK covered in microwavable casserole. Stir once halfway through cooking.
4 cups	6-9 minutes	
Rice 1 cup	1-3 minutes	COOK covered in microwavable casserole. Stir once halfway through cooking.
4 cups	3-5 minutes	
Sandwich roll or bun 1 roll	15-30 seconds	Wrap in paper towel and place on glass microwavable rack
Vegetables 1 cup	1-2 minutes	COOK covered in microwavable casserole. Stir once halfway through cooking.
4 cups	2-4 minutes	
Soup 1 serving (8 oz.)	1-2 minutes	COOK covered in microwavable casserole. Stir once halfway through cooking.

## Fresh Vegetable Chart

Vegetable	Amount	Cook time at HIGH	Instructions	Standing Time
Artichokes (8oz. each)	2 medium 4 medium	5-7 7-10	Trim. Add 2 tsp water and 2 tsp juice. Cover.	2-3 minutes
Asparagus, Fresh, Spears	1lb.	3-6	Add 1/2 cup water. Cover.	2-3 minutes
Beans, Green & Wax	1 lb.	4-7	Add 1/2 cup water in 1 1/2 qt. casserole. Stir halfway through cooking.	2-3 minutes
Beets, Fresh	1 lb.	5-8	Add 1/2 cup water in 1 1/2 qt. covered casserole. Rearrange halfway through cooking.	2-3 minutes
Broccoli, Fresh, Spears	1lb.	4-7	Place broccoli in baking dish. Add 1/2 cup water.	2-3 minutes
Cabbage, Fresh, Chopped	1lb.	4-7	Add 1/2 cup water in 1 1/2 qt. covered casserole. Stir halfway through cooking.	2-3 minutes
Carrots, Fresh, Sliced	2 cups	2-4	Add 1/4 cup water in 1 qt. covered casserole. Stir halfway through cooking.	2-3 minutes
Cauliflower, Fresh, Whole	1lb.	4-7	Trim. Add 1/4 cup water in 1 qt. covered casserole. Stir halfway through cooking.	2-3 minutes
Flowerettes, Fresh	2 cups	2-4	Slice. Add 1/2 cup water in 1 1/2 qt. covered casserole.	2-3 minutes
Celery, Fresh, Sliced	4 cups	5-8	Stir halfway through cooking.	2-3 minutes
Corn, Fresh	2 ears	5-9	Husk. Add 2 tbsp water in 1 1/2 qt. baking dish. Cover.	2-3 minutes
Mushrooms, Fresh, Sliced	1/2 lb.	2-3	Place mushrooms in 1 1/2 qt. covered casserole. Stir halfway through cooking.	2-3 minutes
Parsnips, Fresh, Sliced	1lb.	4-7	Add 1/2 cup water in 1 1/2 qt. covered casserole. Stir halfway through cooking.	2-3 minutes
Peas, Green, Fresh	4 cups	5-9	Add 1/2 cup water in 1 1/2 qt. covered casserole. Stir halfway through cooking.	2-3 minutes
Sweet Potatoes Whole Baking (6-8 oz. each)	2 medium 4 medium	5-7 8-11	Pierce potatoes several times with fork. Place on 2 paper towels. Turn over halfway through cooking.	2-3 minutes 2-3 minutes
White Potatoes, Whole Baking (6-8 oz. each)	2 potatoes 4 potatoes	5-7 8-11	Pierce potatoes several times with fork. Place on 2 paper towels. Turn over halfway through cooking.	2-3 minutes 2-3 minutes
Spinach, Fresh, Leaf	1lb.	3-5	Add 1/2 cup water in 2 qt. covered casserole.	2-3 minutes
Squash, Acorn or Butternut, Fresh	1 medium	4-6	Cut squash in half. Remove seeds. Place in 8 x 8-inch baking dish. Cover.	2-3 minutes
Zucchini, Fresh, Sliced	1lb.	4-7	Add 1/2 cup water in 1 1/2 qt. covered casserole. Stir halfway through cooking.	2-3 minutes
Zucchini, Fresh, Whole	1lb.	4-8	Pierce. Place on 2 paper towels. Turn zucchini over and rearrange halfway through cooking.	2-3 minutes

## Care of Your Microwave Oven

### BEFORE CLEANING:

Unplug at socket of the oven. If impossible, leave oven door open to prevent oven from accidentally turning on.

### AFTER CLEANING:

Be sure to replace the Rotating Ring and Glass Tray in the proper position and press **Stop/Reset** Pad to clear the screen.

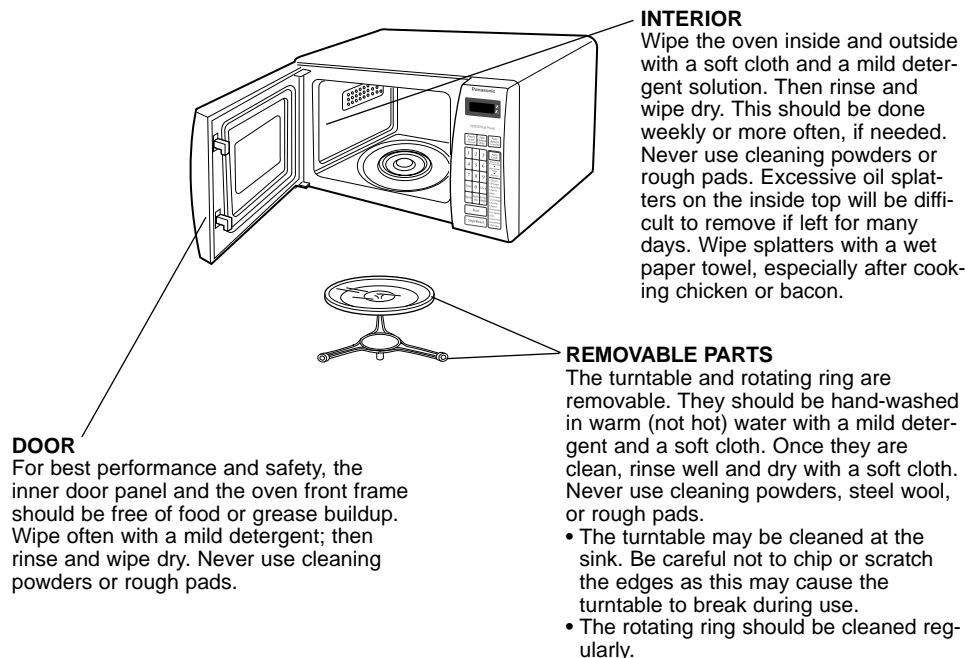

## Before Requesting Service

### All these things are normal:

The oven causes interference with my TV.	Some radio and TV interference might occur when you cook with the microwave oven. This interference is similar to the interference caused by small appliances such as mixers, vacuums, blow dryers, etc. It does not indicate a problem with your oven.
Steam accumulates on the oven door and warm air comes from the oven vents.	During cooking, steam and warm air are given off from the food. Most of the steam and warm air are removed from the oven by the air which circulates in the oven cavity. However, some steam will condense on cooler surfaces such as the oven door. This is normal.
I accidentally ran my microwave oven without any food in it.	Running the oven empty for a short time will not damage the oven. However, we do not recommend operating the microwave oven without any food in it.
The oven lights dim.	When cooking with a power other than HIGH, the oven must cycle to obtain the lower power levels. The oven light will dim and clicking noises can be heard when the oven cycle.

PROBLEM		POSSIBLE CAUSE	REMEDY
Oven will not turn on.	→	The oven is not plugged in securely.	Remove plug from outlet, wait 10 seconds and reinsert.
		Circuit breaker or fuse is tripped or blown.	Reset circuit breaker or replace fuse.
		There is a problem with the outlet.	Plug another appliance into the outlet to check if it is working.
Oven will not start cooking.	→	The door is not closed completely.	Close the oven door securely.
		<b>Start</b> Pad was not pressed after programming.	Press <b>Start</b> Pad.
		Another program is already entered into the oven.	Press <b>Stop/Reset</b> Pad to cancel the previous program and enter new program.
		The program is not correct.	Program again according to the Operating Instructions.
		<b>Stop/Reset</b> Pad has been pressed accidentally.	Program oven again.
The Glass Tray wobbles.	→	The Glass Tray is not positioned properly on the Rotating Ring or there is food under the Rotating Ring.	Take out Glass Tray and Rotating Ring. Wipe with a damp cloth and reset Rotating Ring and Glass Tray properly.
When the oven is operating, there is noise coming from the Glass Tray.	→	The Rotating Ring and oven bottom are dirty.	Clean these parts according to <b>Care of Your Microwave Oven.</b>
The word "L" appears in the <b>Display Window.</b>	→	The CHILD LOCK was activated by pressing  pad.	Hold " " pad until " <b>L</b> " disappears from the display.

## Limited Warranty & Customer Services

PANASONIC CONSUMER ELECTRONICS COMPANY,  
DIVISION OF MATSUSHITA ELECTRIC  
CORPORATION OF AMERICA  
One Panasonic Way  
Secaucus, New Jersey 07094

PANASONIC SALES COMPANY,  
DIVISION OF MATSUSHITA  
ELECTRIC OF PUERTO RICO, INC.,  
Ave. 65 de Infanteria, Km. 9.5  
San Gabriel Industrial Park  
Carolina, Puerto Rico 00985

## Panasonic Microwave Oven Product Limited Warranty

### Limited Warranty Coverage

If your product does not work properly because of a defect in materials or workmanship, Panasonic Consumer Electronics Company or Panasonic Sales Company (collectively referred to as "the warrantor") will, for the length of the period indicated on the chart below, which starts with the date of original purchase ("warranty period"), at its option either (a) repair your product with new or refurbished parts, or (b) replace it with a new or a refurbished product. The decision to repair or replace will be made by the warrantor.

	<u>PARTS</u>	<u>LABOR</u>
ALL PARTS(EXCEPT MAGNETRON TUBE)	<b>1 (ONE) YEAR</b>	<b>1 (ONE) YEAR</b>
MAGNETRON TUBE	<b>5 (FIVE) YEAR</b>	<b>1 (ONE) YEAR</b>

During the "Labor" warranty period there will be no charge for labor. During the "Parts" warranty period, there will be no charge for parts. You must carry-in or mail-in your product during the warranty period. This warranty only applies to products purchased and serviced in the United States or Puerto Rico. This warranty is extended only to the original purchaser of a new product which was not sold "as is". A purchase receipt or other proof of the original purchase date is required for warranty service.

### Carry-In or Mail-In Service

For Carry-In or Mail-In Service in the United States call 1-800-211-PANA(7262) or visit Panasonic Web Site: <http://www.panasonic.com>  
For assistance in Puerto Rico call Panasonic Sales Company (787)-750-4300 or fax (787)-768-2910.

### Limited Warranty Limits And Exclusions

This warranty ONLY COVERS failures due to defects in materials or workmanship, and DOES NOT COVER glass, plastic parts, temperature probes(if included) and normal wear and tear or cosmetic damage. The warranty ALSO DOES NOT COVER damages which occurred in shipment, or failures which are caused by products not supplied by the warrantor, or failures which result from accidents, misuse, abuse, neglect, mishandling, misapplication, alteration, faulty installation, set-up adjustments, misadjustment of consumer controls, improper maintenance, power line surge, lightning damage, modification, or commercial use (such as in a hotel, office, restaurant, or other business), rental use of the product, service by anyone other than a Factory Servicenter or other Authorized Servicer, or damage that is attributable to acts of God.

## Limited Warranty & Customer Services

**THERE ARE NO EXPRESS WARRANTIES EXCEPT AS LISTED UNDER "LIMITED WARRANTY COVERAGE". THE WARRANTOR IS NOT LIABLE FOR INCIDENTAL OR CONSEQUENTIAL DAMAGES RESULTING FROM THE USE OF THIS PRODUCT, OR ARISING OUT OF ANY BREACH OF THIS WARRANTY.** (As examples, this excludes damages for lost time, cost of having someone remove or re-install an installed unit if applicable, or travel to and from the servicer. The items listed are not exclusive, but are for illustration only.) **ALL EXPRESS AND IMPLIED WARRANTIES, INCLUDING THE WARRANTY OF MERCHANTABILITY, ARE LIMITED TO THE PERIOD OF THE LIMITED WARRANTY.**

Some states do not allow the exclusion or limitation of incidental or consequential damages, or limitations on how long an implied warranty lasts, so the exclusions may not apply to you.

This warranty gives you specific legal rights and you may also have others rights which vary from state to state. If a problem with this product develops during or after the warranty period, you may contact your dealer or Servicenter. If the problem is not handled to your satisfaction, then write to the warrantor's Consumer Affairs Department at the addresses listed for the warrantor.

**PARTS AND SERVICE WHICH ARE NOT COVERED BY THIS LIMITED WARRANTY ARE YOUR RESPONSIBILITY.**

### For Product

*For Product Information, Operating Assistance, Literature Request, Dealer Locations, and all Customer Service inquiries please contact:*  
**1-800-211-PANA (7262), Monday-Friday 9 am-9 pm; Saturday-Sunday 9 am-7 pm, EST.**

### Web Site

*Web Site: <http://www.panasonic.com>  
You can purchase parts, accessories or locate your nearest servicer by visiting our Web Site.*

### Accessory

#### Accessory Purchases:

1-800-332-5368 (Customer Orders Only)  
Panasonic Services Company 20421 84th Avenue South, Kent, WA 98032  
(6 am to 5 pm Monday-Friday; 6 am to 10:30 am Saturday; PST)  
(Visa, MasterCard, Discover Card, American Express, Check)

### Service in Puerto Rico

*Service in Puerto Rico*  
**Matsushita Electric of Puerto Rico, Inc. Panasonic Sales Company/Factory Servicenter:**  
**Ave. 65 de Infantería, Km. 9.5, San Gabriel Industrial Park, Carolina, Puerto Rico 00985**  
**Phone (787) 750-4300 Fax (787) 768-2910**

## INSTRUCCIONES DE SEGURIDAD

Su horno de microondas es un artículo para cocinar y usted debe usarlo con tanto cuidado como usa una estufa o cualquier otro artículo para cocinar. Cuando utilice este aparato eléctrico, se deben seguir precauciones básicas de seguridad, incluyendo las siguientes:

**PRECAUCIÓN**—To reduce the risk of burns, electric shock, fire, injury to persons, or exposure to excessive microwave energy:

1. Lea todas las instrucciones antes de usar el aparato.
2. Lea y siga las **"PRECAUCIONES PARA EVITAR POSIBLE EXPOSICION EXCESIVA A ENERGIA DE MICROONDAS"** específicas, que se encuentran abajo.
3. Este aparato debe ser conectado a tierra. Conecte solamente a la toma eléctrica debidamente conectada a tierra. Vea las **"INSTRUCCIONES PARA CONEXIÓN A TIERRA"** que se encuentran en la página 24.
4. Instale o ubique este aparato solamente de acuerdo con las instrucciones de instalación que se encuentran en la página 25.
5. No cubra ni tape ninguna de las rendijas de este aparato.
6. No almacene o use este aparato en exteriores. No use este aparato cerca del agua - por ejemplo, cerca del fregadero de la cocina, en una base mojada, o cerca de una alberca, y similares.
7. Use este aparato sólo para los fines para los que fué hecho, tal como se describen en este manual. No use químicos o vapores corrosivos en este aparato. Este tipo de horno está específicamente diseñado para calentar o cocinar alimentos. No fué diseñado para uso industrial o de laboratorio.
8. Cuando limpie las superficies de la puerta y el horno que vienen juntas al cerrar la puerta, use solamente jabones no abrasivos o detergentes suaves aplicados con una esponja o con tela suave.
9. No permita a los niños usar este aparato, a menos que sean supervisados muy de cerca por un adulto.
10. No use este aparato si tiene dañado el cordón o la clavija, si no está trabajando adecuadamente, o si ha sido dañado o se ha dejado caer.
11. No sumergir en agua el cable o la clavija.
12. Mantenga el cordón lejos de superficies calientes.
13. No deje el cordón colgando en el borde de la mesa o mostrador.
14. Este aparato debe recibir mantenimiento sólo de personal calificado. Contacte las instalaciones de servicio autorizadas más cercanas para revisión, reparación o ajuste.
15. Algunos productos, tales como los huevos completos y contenedores sellados - por ejemplo frascos de vidrio cerrados - pueden explotar y no deben ser calentados en este horno.
16. Para reducir el riesgo de incendio en la cavidad del horno:
  - (a) No sobrecocine los alimentos. Preste atención cuidadosamente al aparato. El papel, plástico u otros materiales combustibles son colocados dentro del horno para facilitar la cocción pero si no se utilizan adecuadamente esto puede producir incendio en su horno.
  - (b) Quite los sujetadores de alambre de las bolsas de papel o plástico antes de colocar la bolsa en el horno.
  - (c) Quite los sujetadores de alambre de las bolsas de papel o plástico antes de colocar la bolsa en el horno.
  - (d) No use la cavidad con propósitos de almacenaje. No deje productos de papel, utensillos de cocina o alimentos en la cavidad cuando no esté en uso.

## Guarde estas instrucciones

### PRECAUCIONES PARA EVITAR POSIBLE EXPOSICION EXCESIVA A ENERGIA DE MICROONDAS

- (a) No intente hacer funcionar este horno con la puerta abierta ya que esto puede resultar peligroso. Es importante no anular o biogear los mecanismos de seguridad.
- (b) No coloque ningún objeto entre el panel frontal del horno y la puerta, ni permita que se acumule basura o residuos de limpiadores en las superficies de sellado.
- (c) No haga funcionar el horno si está dañado, es importante que la puerta del horno abra y cierre apropiadamente:
  - (1) la puerta (combada)
  - (2) bisagras y seguro de la puerta (rotos o sueltos)
  - (3) sellos de las puertas y superficies de sellado
- (d) El horno o deberá ser ajustado o reparado por ninguna persona, excepto el personal de servicio debidamente calificado.

# INSTRUCCIONES DE SEGURIDAD

## Uso General

- NO** altere o haga ningún ajuste o reparación a la puerta, al alojamiento del panel de control, interruptores entrecruzados de seguridad o a cualquier otra parte del horno. **NO** quite el panel exterior del horno. Las reparaciones deben ser hechas solamente por personal de servicio calificado.
- NO** opere el horno vacío. La energía de microondas se reflejará continuamente a través del horno si los alimentos o agua no están presentes para absorber energía. Esto puede dañar el horno y resultar en peligro de incendio.
- NO** utilice este horno para calentar químicos o cualquier otros productos no alimenticios. **NO** limpie este horno con cualquier producto etiquetado con contenido químico corrosivo. El calentamiento de químicos corrosivos en este horno puede causar fugas de radiación.
- NO** seque telas, periódicos u otros materiales en el horno. Pueden incendiarse.

- NO** use productos de papel reciclado, ya que pueden contener impurezas que pueden causar chispas y/o incendios cuando se usen.
- NO** use periódicos o bolsas de papel para cocinar. Puede causar un incendio.
- NO** pegue, **NO** golpee el panel de control. Pueden causarse daños a los controles. Puede causar un incendio.
- Las manoplas para tomar cosas calientes siempre deben ser utilizados cuando se retiren cosas de el horno. El calor se transfiere de los alimentos calientes a los contenedores para cocinar y de los contenedores a la Bandeja de Cristal. La Bandeja de Cristal puede estar muy caliente después de sacar los contenedores para cocinar del horno.
- NO** almacene materiales flamables cerca, arriba, o dentro del horno. Pueden ser riesgos de incendio.

# INSTRUCCIONES PARA CONEXIÓN A TIERRA

Este aparato debe ser conectado a tierra. En el caso de un corto circuito, la conexión a tierra reduce el riesgo de una descarga eléctrica proporcionando una línea de escape para la corriente eléctrica. Este aparato está equipado con un cable y clavija para conexión a tierra. La clavija debe ser conectada en un receptor que esté instalado adecuadamente y conectado a tierra.

**PRECAUCION** - El uso inapropiado de la clavija para conexión a tierra puede resultar en riesgo de descarga eléctrica.

Consulte a un electricista o a personal de servicio calificados, si las instrucciones para conectar a tierra no son completamente comprendidas o si existe duda de que el aparato está correctamente conectado a tierra. Si es necesario usar un cable de extensión, use solamente cable de extensión de tres hilos que tenga una clavija de tres entradas para conectar a tierra, y un receptor de tres ranuras que acepte la clavija del aparato. El calibre marcado en el cable de extensión debe ser igual o mayor al calibre eléctrico del aparato.

## Suministro Eléctrico

- Se provee un cable de suministro eléctrico corto para reducir los riesgos resultantes de enredarse o tropezarse con un cable más largo.
- Juegos de cable más largos o extensiones están disponibles y pueden utilizarse si se usan con cuidado.
- Si se usa un cable más largo o extensión, (1) el calibre eléctrico marcado en el juego de cordón o extensión debe ser al menos tan grande como el calibre eléctrico del aparato, (2) el cable de extensión debe ser de tres hilos del tipo de conexión a tierra, y (3) el cordón más largo debe ser arreglado de tal forma que no caiga sobre la cubierta del mostrador o de la mesa donde pueda ser jalado por niños o tropezarse accidentalmente.

# INSTRUCCIONES DE INSTALACIÓN

## Examine Su Horno

Desempaque el horno, quite todo el material de empaque y examine que su horno no tenga ningún daño, tales como abolladuras, seguros de la puerta rotos o resquebrajaduras en la puerta. Notifique inmediatamente a su distribuidor si el horno está dañado.

## Ubicación del Horno

- El horno debe ser colocado en una superficie plana y estable. Para su operación apropiada, el horno debe tener suficiente corriente de aire. Deje 10 cm de espacio de ambos lados del horno y 10 cm de espacio en la parte superior del horno.
  - NO** bloquee la ventilación del aire. Si es bloqueada la ventilación del aire durante la operación, el horno puede sobrecalentarse y quemarse. Cuando use algún trapo, franela o funda para cubrir el horno, las tomas y salidas del aire no deberán ser bloqueadas. También debe tener un espacio apropiado para la parte trasera y los costados.
  - NO** coloque el horno cerca de una superficie húmeda caliente, tal como un registro de gas o eléctrico.
  - NO** opere el horno cuando la humedad del cuarto sea muy alta.
- Este horno ha sido fabricado para uso en el hogar solamente.

## Interferencia de Radio

- La operación de su horno de microondas puede causar interferencia en su radio, TV o equipo similar.
- Cuando hay interferencia, se puede reducir o eliminar tomando las siguientes medidas:
  - Limpie la puerta y las superficies selladoras del horno.
  - Ponga el radio, TV, etc. lo más lejos posible del horno de microondas.
  - Use una antena instalada adecuadamente para obtener una recepción de señal más fuerte.

# Requerimientos de cableado

- El horno debe estar en un circuito separado. Ningún otro aparato debe compartir el circuito con el horno. Si lo hace el fusible del circuito puede estallar, el bloqueador del circuito trabarse o la comida cocinarse más lento que en los tiempos recomendados en este manual.
- El voltaje usado debe ser el mismo al especificado en el horno de microondas (120 V.). Usar un voltaje más alto es peligroso y puede resultar en fuego u otro accidente causando daño al horno. Usar un bajo voltaje dará como resultado un cocinado más lento. Panasonic no se hace responsable por daños resultantes del uso del horno con otros voltajes que no sea el especificado.
- El horno debe ser conectado en un enchufe a tierra de al menos 20 amp 120 volt, 60 Hz. Donde se encuentre un enchufe estándar de 2 entradas es responsabilidad y obligación del consumidor reemplazarlo por un enchufe a tierra de 3 entradas.

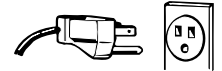

## Especificaciones Técnicas

	NN-S723WL/BL
Potencia Fuente de Poder:	13,5 Amps, 1600 W
Potencia de Salida:*	1200 W
Dimensiones Exteriores (Alto x Ancho x Fondo):	344 x 573,5 x 440 mm
Dimensiones Cavidad del Horno (Alto x Ancho x Fondo):	261 x 421 x 424 mm
Frecuencia:	2450 MHz
Peso Sin Embalaje:	Aprox. 16,9 kg

\*Determinado de acuerdo a procedimientos contemplados en la norma IEC 60705. Las especificaciones están sujetas a cambios sin previo aviso.

## Sugerencias Útiles

### Siga Esta Precauciones de Seguridad Cuando Cocine en Su Horno

#### IMPORTANTE

La cocción adecuada depende del tiempo designado y del peso de los alimentos. Si usa una porción menor de la recomendada y cocina por el tiempo para la porción recomendada, puede resaltar un incendio. Si ocurre un incendio, ponga el horno en posición de apagado y manténgalo cerrado. Desconecte la energía eléctrica o desconecte la caja de fusibles o el panel de control.

#### 1) ENLATADO CASERO/ALIMENTOS DESHIDRATADOS/PEQUEÑAS CANTIDADES DE ALIMENTOS

- No use su horno para el enlatado casero o para calentar cualquier frasco cerrado. La presión aumentará y el frasco puede explotar. Su horno no puede mantener los alimentos a la temperatura apropiada de enlatado.
- Pequeñas cantidades de alimento o alimentos con bajo contenido de humedad se pueden secar, quemar o incendiarse.
- No seque alimentos, hierbas, frutas o vegetales en su horno.

#### 2) PALOMITAS DE MAÍZ

Las palomitas de maíz deben prepararse en un recipiente para palomitas de maíz adecuado para horno de microondas. Palomitas de maíz para horno de microondas que se preparan en su propio paquete también están disponibles. Siga las instrucciones del fabricante de palomitas de maíz y use una marca adecuada para la potencia de su horno de microondas. Nunca deje desatendido el horno cuando prepare palomitas de maíz.

#### PRECAUCIÓN

**Cuando use palomitas de maíz para microondas previamente empacado siga las instrucciones recomendadas en el paquete. Revise el peso del paquete antes de usar la tecla de palomitas de maíz. Prepare el horno para el peso del paquete de palomitas de maíz. Si no se siguen estas instrucciones, las palomitas de maíz pueden no reventar adecuadamente o pueden encenderse y causar un incendio.**

#### 3) FREIR CON MUCHA GRASA

- No trate de freír con mucha grasa en su horno de microondas. Cocinar aceites puede estallar en flamas y puede causar daño al horno y quizá acabar en quemaduras. Los utensilios de microondas pueden no ser útiles para soportar la temperatura del aceite caliente, y podrían romperse.

#### 4) HUEVOS

- No caliente huevos en su cascara en el horno de microondas. La presión subirá y el huevo explotará.

#### 5) ALIMENTOS CON PIELS NO POROSAS

- Papas, manzanas, yemas de huevo, calabazas completas y salchichas son ejemplos de alimentos con pieles no porosas. Estos tipos de alimentos deben ser perforados antes de cocinarlos en Microondas para evitar que Estallen.

- Use papas frescas para hornear y cocinelas hasta que estén listas. Cocinar demasiado causa deshidratación y puede producir un incendio. Use los pesos recomendados o puede ocurrir un incendio.

#### 6) LIQUIDOS

- Los líquidos pueden "sobrecalentarse" en el microondas y, cuando el recipiente se desplaza en un sentido, los líquidos sobrecalentados pueden "desbordarse" fuera del recipiente. El agua "sobrecalentada" es más caliente que el agua hervida, AUNQUE NO HAGA BURBUJAS. Para reducir la posibilidad de que esto ocurra, siempre debe agitar con fuerza los líquidos antes de calentarlos para que el líquido se mezcle con aire. **NO CALIENTE NUNCA LOS LIQUIDOS DURANTE UN TIEMPO PROLONGADO.**

#### 7) BANDEJA DE CRISTAL/UTENSILIOS DE COCINA/PAPEL ALUMINIO

- Los utensilios para cocinar se calientan durante la cocción en microondas. Use soportes para lo caliente, cuando saque los utensilios del horno o cuando quite tapas o cubiertas de envoltura de plástico de los utensilios de cocina, para evitar quemaduras.
- La bandeja de cristal se calentará durante la cocción. Debe permitirse que se enfríe antes de manejarla o antes de colocar productos de papel, tales como platos de papel o bolsas de palomitas de maíz para microondas, para cocinar.
- Cuando se use papel aluminio, brochetas, rejillas para calentar o utensilios hechos de metal en el horno, deje por lo menos 2,5 cm de espacio entre el material de metal y las paredes interiores del horno. Si arquea (chispea) quite el material de metal (brochetas etc.) y/o cambíelo a un contenedor no metálico.
- Platos con adornos metálicos no deben ser usados, ya que puede producirse arco eléctrico.

#### 8) TOALLAS DE PAPEL/TELAS

- No use toallas de papel o telas que contengan fibras sintéticas en su tejido. La fibra sintética puede causar que la toalla se incendie.
- No use bolsas de papel o productos de papel reciclado en el horno de microondas.

#### 9) BANDEJA DORADOR/BOLSAS PARA COCINAR EN HORNO

- Los bandeja doradora o asados son diseñados para cocinar en microondas solamente. Siempre siga las instrucciones dadas por el fabricante. No precaliente la bandeja doradora mas de 8 min.
- Si se usa una bolsa para cocinar para el microondas, prepare de acuerdo a las instrucciones del paquete. No use sujetadores de alambre para cerrar la bolsa.

#### 10) TERMÓMETROS

- No use termómetros convencionales para alimentos en su horno. Puede producir arco.

#### 11) GUÍA DE USO GENERAL DEL HORNO/PUERTA DEL HORNO

- No use el horno por cualquier razón que no sea la preparación de alimentos.
- No deje sin atención el horno mientras esté en uso.

## Panel de Control

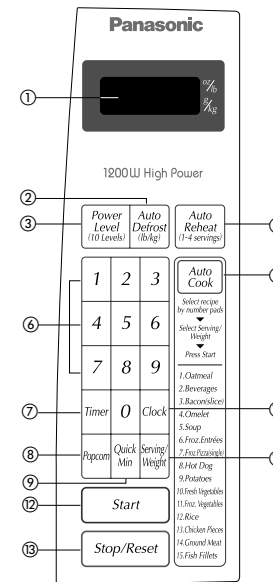

- Pantalla indicadora (Ventana de Visualización)
- Cocción a tiempo programado
- Pulsador de potencia
- Pulsador de recalentamiento automático
- Pulsadores de auto cocción
- Pulsadores de numéricos
- Pulsador de tiempo
- Pulsador de palomitas de maíz
- Pulsador de rapido en minutos
- Pulsador de reloj
- Pulsador de porción/peso
- Pulsador Para Comenzar
- Pulsador Para/Cancelar

## Sugerencias

### Nivel de Potencia

Pulse	Nivel de Potencia
1 vez	P10 (Alto)
2 veces	P9
3 veces	P8
4 veces	P7 (Medio-alto)
5 veces	P6 (Medio)
6 veces	P5
7 veces	P4
8 veces	P3 (Medio-bajo)
9 veces	P2
10 veces	P1 (Bajo)

### Pulsador de Palomitas

Pulse	Peso
1 vez	1.75 oz. (50g)
2 veces	3.0 oz. (85g)
3 veces	3.5 oz. (99g)

#### Notas:

- Use los paquetes previamente empacados de palomitas de maíz para microondas a temperatura ambiente. Lea las instrucciones del fabricante.
- Coloque la bolsa en el horno de acuerdo a las instrucciones del fabricante.
- Coloque solamente una bolsa a la vez.
- Después de preparadas, abra la bolsa cuidadosamente, las palomitas de maíz y el vapor estarán extremadamente calientes.
- No vuelva a calentar los granos que no reventaron ni vuelva a usar la bolsa.
- Nunca deje el horno desatendido cuando prepare palomitas de maíz. Pare el horno cuando la explosión de las palomitas demore entre 2 y 3 segundos. El exceso de cocción puede hacer que las palomitas se quemen.
- Debido a la gran variedad de palomitas de maíz para microondas en el mercado, tal vez sea necesario poner la bolsa en la orilla del plato giratorio para obtener mejores resultados.

**NOTA ACERCA DE PALOMITAS:** Cuando se preparen varias bolsas una tras otra, el tiempo de preparación puede variar ligeramente. Esto no afecta al resultado de las palomitas.

**PRECAUCIÓN:** Si el paquete de palomitas de maíz previamente empacado es de un peso diferente a el recomendado, no use el sistema indicado para palomitas de maíz, o puede ocurrir que no se preparen adecuadamente o un incendio. Siga las instrucciones del fabricante.

## Auto Cook

Use esta función para cocinar los alimentos sin indicar el tiempo o potencia de cocción. Para mayor información, consulte la Tabla de Cocción Automática (Auto Cook.)

**Ejemplo:** Para cocinar una 300 g. de una Entrada congelada

<b>1.</b>		• Oprima.
<b>2.</b>		• Seleccione el número de categoría deseada usando las teclas numéricas.

<b>3.</b>		• Oprima hasta que la cantidad deseada se muestre en la <b>Pantalla</b> .
<b>4.</b>		• Oprima. ▶ El tiempo de cocción aparece en la <b>Pantalla</b> y comienza la cuenta regresiva.

## TABLA DE COCCIÓN AUTOMÁTICA (AUTO COOK)

Tecla	Porción / peso	Consejos
<b>1. Avena</b>	1/2, 1 taza	Coloque la avena en un tazón para microondas y agregue agua de acuerdo con las instrucciones del paquete. No tape. Mezcle bien después de calentarla.
<b>2. Bebidas</b>	1, 2 tazas	Use un tarro o taza para microondas, sin tapa. Mezcle después de recalentar.
<b>3. Tocino (rebanada)</b>	4, 6, 10 rebanadas	Coloque las rebanadas de tocino sobre 3 toallas de papel en un platón para microondas. Cubra con otra toalla de papel. Si el tocino no se cocina a su gusto, continúe calentando manualmente aumentando el tiempo.
<b>4. Tortilla de huevos</b>	2, 4 huevos	< Ingredientes para 2 huevos > 1 cucharadita de mantequilla o margarina 2 cucharaditas de leche sal y pimienta negra en polvo Derrita la mantequilla en un molde para pie de 20 cm. , haga girar el molde para cubrir el fondo con la mantequilla. Mezcle el resto de los ingredientes y vacíe en el molde para pie y cubra con envoltura plástica ventilada. Deje reposar por 2 minutos. Con una espátula, separe las orillas de la tortilla del molde. Doble en tres para servir.
<b>5. Sopa</b>	1, 2 tazas	Vacíe la sopa en un tazón para microondas. Cubra parcialmente con una tapa o con envoltura plástica ventilada. Mezcle después de recalentar.
<b>6. Entradas congeladas</b>	10,20 oz. (284,567g)	Siga las instrucciones del paquete para cubrir las.
<b>7. Pizza congelada (individual)</b>	4,8 oz. (113,227g)	Siga las instrucciones del fabricante.
<b>8. Hot Dog</b>	1, 2, 3, 4 piezas	Haga unos cortes ranurados en las salchichas y coloque sobre toallas de papel.
<b>9. Papas</b>	1, 2, 3, 4 piezas	Pique la piel con un tenedor y coloque sobre una toalla de papel. No las cubra. Deje reposar por 5 minutos después de cocinarlas.
<b>10. Vegetales frescos</b>	4,8,12,16 oz. (113,227,340,454g)	Todos los pedazos deben ser del mismo tamaño. Agregue una pequeña cantidad de agua y cubra con una tapa o envoltura plástica.
<b>11. Vegetales congelados</b>	6,10,16 oz. (170,284,454g)	Agregue una pequeña cantidad de agua y cubra con una tapa o envoltura plástica ventilada. Revuelva al sonido bip para una cocción pareja.
<b>12. Arroz</b>	1/2, 1, 1 1/2 tazas	Agregue el doble de agua caliente y cubra con envoltura plástica.
<b>13. Piezas de pollo</b>	6,12,18,24 oz. (170,340,510,680g)	Coloque las piezas de pollo con la piel hacia arriba y cubra con envoltura plástica.
<b>14. Carne molida</b>	16,32 oz. (454,907g)	Cubra con envoltura plástica. Revuelva al sonido bip para una cocción pareja.
<b>15. Filetes de pescado</b>	4,8,12,16 oz. (113,207,340,454g)	Coloque los filetes en una sola capa y cubra con envoltura plástica.

## GUIA RAPIDA DE OPERACIÓN

Característica	Como Opera
Para Poner el Reloj en la Hora (Vea página 9)	→  a  → Presione.      Registre la hora o día.      Presione.
Para Ajuste de Potencia y Tiempo (Vea página 9)	→  a  → Seleccione potencia.      Establezca el tiempo de cocción.      Presione.
Minuto Automático (Vea página 9)	→ (hasta a 10)      Presione.
Para Descongelar usando el pulsador (Vea página 12)	→  a  → Presione.      Fije el peso.      Presione.
Para Cocinar usando el Pulsador Auto Cocción (Vea página 14)	eg.  →  → Seleccione Recipe      Seleccione porciones/peso      Presione.
Para Usar como en temporizador de cocina (Vea página 10)	→  a  → Presione.      Presione.
Traba Para Niños-Activacion (Vea página 9)	 Mantenga "Start" presionado hasta que el siguiente mensaje aparezca en el indicador "L" y se escuchen dos "beeps"      Presione y mantenga presionada la tecla "Start" hasta que la leyenda "L" desaparezca del indicador.
Para recalentar usa <b>Auto Reheat</b> pulsador (Vea página 11)	→ Presione.      Presione.